

Accelerate Your Time to Insight

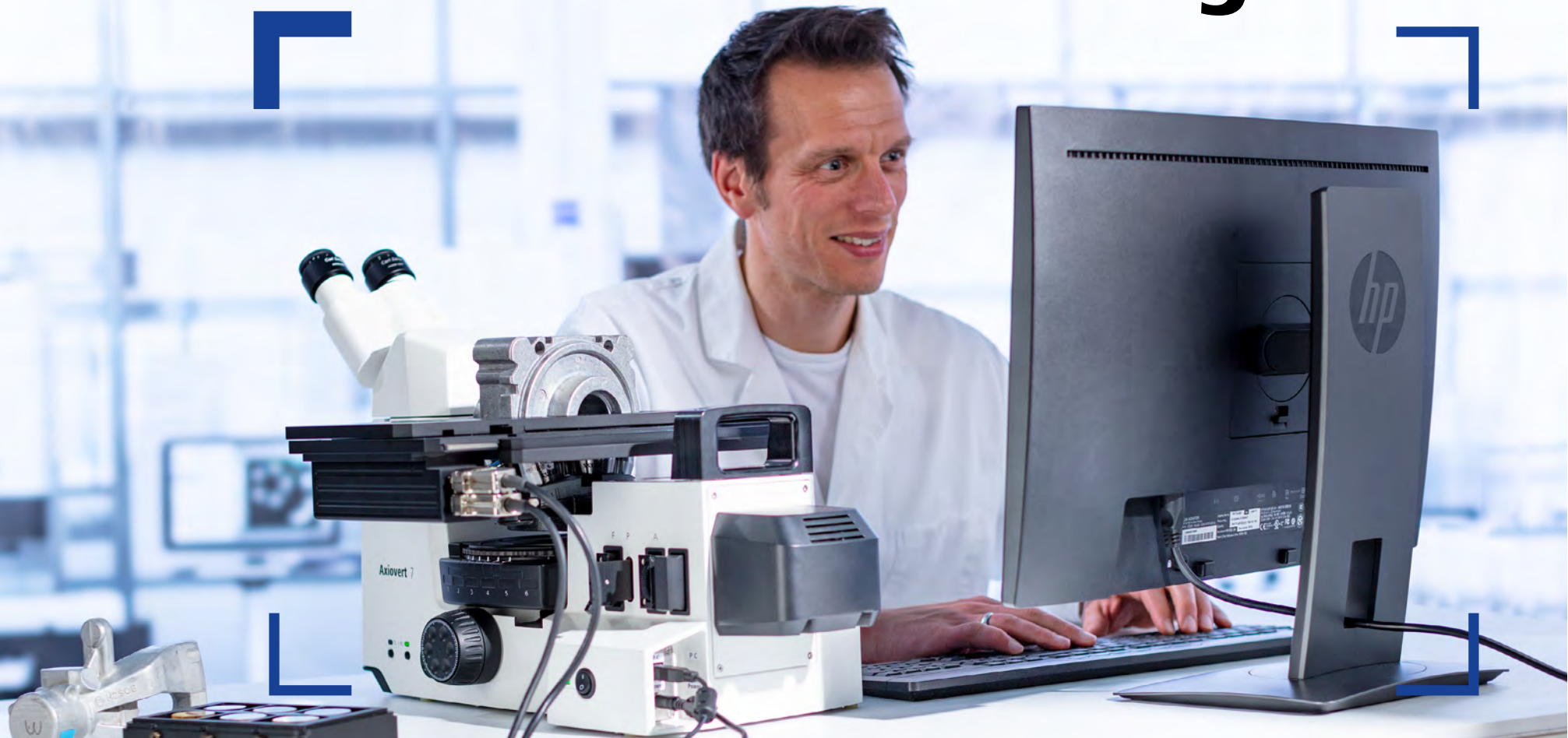

ZEISS Axiovert System

Your Inverted Microscope System for the Materials Lab and Smart Documentation

zeiss.com/axiovert-mat



Seeing beyond

Your Microscope for the Materials Lab and Smart Documentation

- › In Brief

- › The Advantages

- › The Applications

- › The System

- › Technology and Details

- › Service

If you're looking for a compact microscope that effortlessly produces high quality images of even large and heavy samples, then look no further than ZEISS Axiovert.

This inverted microscope is a joy to use in the materials lab for routine and research tasks. With an ergonomic design and smart technology, let the system take care of selecting optimal settings for a consistently well illuminated and sharp image. And if you want to increase productivity even further, opt for additional automation features with a motorized Z-focus and stage.

With Axiovert 5, you don't even need a PC to view and document images – just connect with a monitor and save directly to a USB device.

Select the right system for your needs with a choice between the manual Axiovert 5 with smart microscopy for fast and reliable results or the motorized Axiovert 7 for higher demands on workflow automation.



Simpler. More Intelligent. More Integrated.

- › In Brief
- › **The Advantages**
- › The Applications
- › The System
- › Technology and Details
- › Service

Discover Smart Microscopy.

Focus. Snap. Done.

Axiovert is a smart microscope, delivering excellent results with fast time to image. Simply focus and press a single button to save a high-quality image of your material sample.

Change samples with no need for refocusing to save time and effort. Just place the sample on the stage, focus once and stay in focus for further samples, even when changing magnification.

Powerful Digital Documentation System.

All Your Needs are Covered.

Axiovert makes your routine tasks easier and more convenient. With a wide range of classic and advanced contrast methods, you can examine even large and heavy samples with stability.

Extend your throughput with additional automation and future proof your requirements with optional accessories and software.

Ergonomic Operating Concept.

Work Comfortably All Day.

Axiovert is designed to make everyday operations as comfortable and convenient as possible. Controls such as the focus drive, stage drive, light manager and image capture, are ergonomically arranged on the microscope for relaxed and efficient handling.

The light manager provides uniform brightness at all magnifications, eliminating manual adjustments to the lamp intensity when you're changing objectives.

Let the system take care of optimal settings for image acquisition whilst you focus on your results.



Inverted stand design with 6-fold reflector turret and 6-fold nosepiece offers flexibility



Smart documentation system. Just connect Axiovert 5 with a monitor



Access all main controls with one hand

Expand Your Possibilities

- › In Brief
- › **The Advantages**
- › The Applications
- › The System
- › Technology and Details
- › Service

This is Smart Microscopy.

Always stay focused on your sample, thanks to smart microscopy. Camera settings such as white balance, exposure time, and image enhancement functions are done automatically. Without needing additional imaging software or even a computer, you can:

- Snap images and record videos directly
- Use a mouse (and optionally, a keyboard) to control your camera via On Screen Display (OSD)
- Save settings
- Store images with all microscope and camera metadata as well as scaling information
- Predefine the name or rename your image
- Browse and view your snapped images with the file browser
- Connect to Wi-Fi or a network, independently from the ZEISS Axiocam you're using
- Save your data directly at the stand via a USB device.



ZEISS Axiocam 5 comes with a Smart Control Box (SCB), incorporating all interfaces directly at the stand to enable use without a PC

Routine imaging workflow



Smart functionality for digital documentation for routine applications.

Efficiency gain:

Eyes and hands stay on the microscope.



Expand Your Possibilities

- › In Brief
- › **The Advantages**
- › The Applications
- › The System
- › Technology and Details
- › Service

Adapt ZEISS Axiovert 5 to Your Lab Space and Task.

If lab space is limited, you can use Axiovert 5 in standalone mode without the PC and control the microscope via the OSD menu. For your daily checks, use our free imaging app, ZEISS Labscope. Simply download it to your tablet or Windows PC and you're ready for image acquisition. Or for more sophisticated experiments, ZEISS ZEN core imaging software is recommended.

Imaging and Documentation without a PC



Axiovert 5 operates independently of a computer system

ZEISS Labscope for Connected Routine Imaging



Operating Axiovert 5 with Labscope imaging software is ideal for standard imaging

ZEISS ZEN core for Advanced Applications



Use the ZEISS imaging software suite ZEN core to perform advanced imaging and analysis tasks with Axiovert 5 and Axiovert 7

Expand Your Possibilities

- › In Brief
- › **The Advantages**
- › The Applications
- › The System
- › Technology and Details
- › Service

Accelerate Your Materials Characterization with Automation

With Axiovert 7 you will benefit from higher productivity, repeatable processes based on predefined parameters, and better comparability of results thanks to the motorization of the Z-axis and a motorized XY stage.



ZEISS Axiovert 7 with mounting frame for 6 specimens

Take advantage of:

- Autofocus functionality – find the focus position automatically
- Parfocality function – remains in focus when the objective is changed
- Extended depth of field - automatically acquire multiple images at different focus positions (Z-stack) and combine them to create an image with enhanced depth of field
- Panorama images – create composite images of larger sample areas in just a few clicks
- Tiles and positions – record exact, highly resolved images of multiple field of views by automatically scanning predefined areas
- Guided acquisition – take an overview scan, detect regions of interest (ROI) automatically, start detailed scan of these ROI
- Correlative microscopy – examine samples with different light and electron microscopes. Relocate ROIs automatically using ZEN Connect



Guided acquisition – Automatically define regions for the detail scan from an overview image

Expand Your Possibilities

- › In Brief
- › **The Advantages**
- › The Applications
- › The System
- › Technology and Details
- › Service

Full Confidence in Your Data

The coded components of Axiovert not only make your work easier and more comfortable, but also ensure that erroneous operation and the associated falsification of the examination results can be largely ruled out. With Axiovert, you're assured reliable and reproducible results.

Reproducible Results

The coded components of Axiovert detects changes to objectives or contrast techniques, then adjusts dependent parameters – such as light intensity and scaling – automatically. This allows multi-faceted routine workflows to be processed more quickly and easily. Using process parameters that you or others have stored, anyone can reproduce an exact workflow at any time and achieve comparable results, independent of individual users' operating habits or preferences.

10x (Brightfield)

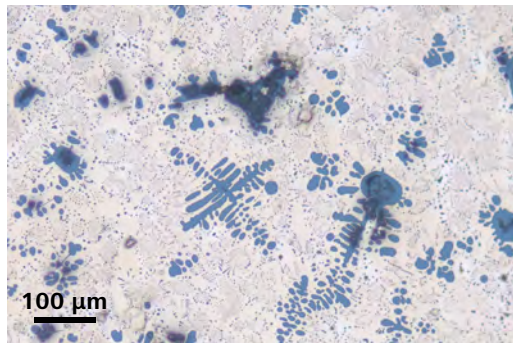

50x (Brightfield)

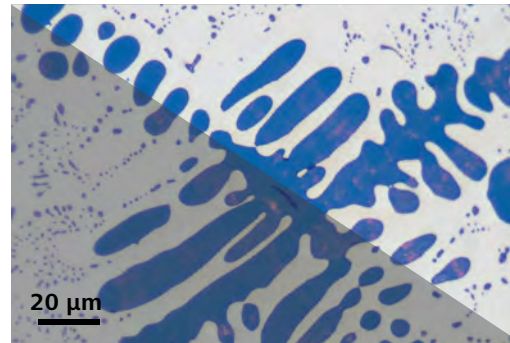

Automatic adjustment of the light intensity after changing the objective (upper right)

50x (Darkfield)

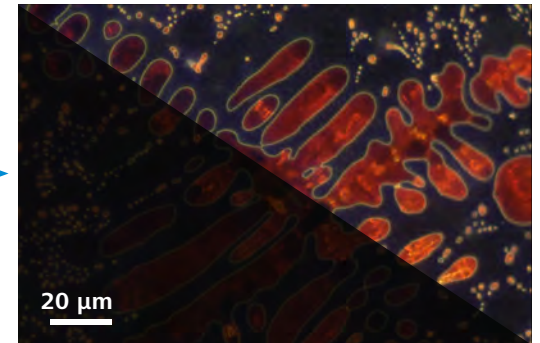

Automatic adjustment of the light intensity after changing the objective and contrasting technique (upper right)

ZEISS Axiovert at Work: Contrast Methods

- › In Brief
- › The Advantages
- › **The Applications**
- › The System
- › Technology and Details
- › Service

Use the contrast method of reflected light brightfield to analyze the microstructures of etched surfaces. Recognizing grain boundaries, you can draw conclusions on grain sizes, phases and structural constituents. See colors and pigments. Detect impurities and structural constituents, such as graphite in cast iron, prior to etching.

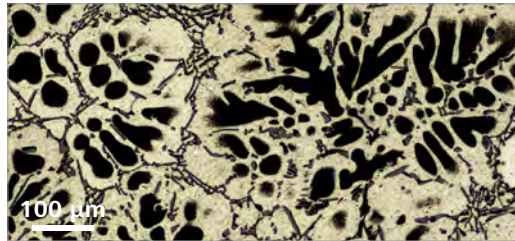

Aluminium alloy, 100x, brightfield

Use the polarization contrast to analyze the structure of anisotropic materials, such as magnesium, aluminum, bronze and brass. In polarized light, the individual grains of crystal lattice will show their characteristic color.



Pure magnesium, 100x, polarization. Photo courtesy: Allied High Tech Products Inc.

In reflected light darkfield, mechanical surface faults such as fracture sites, pores and inclusions show up just as well as cracks, scratches and cavities. You can assess the surface quality of processed work pieces precisely, and make out grain boundaries on etched cuts just as easily.

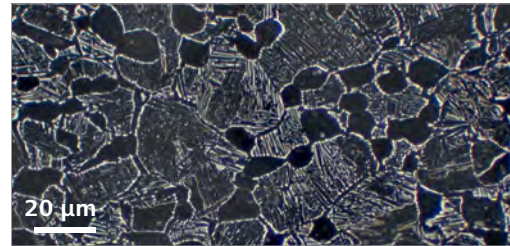

Alpha-Beta Ti, 500x, darkfield. Photo courtesy: Allied High Tech Products Inc.

The Differential Interference Contrast (DIC) lets you detect tiny structural differences in height with particular sensitivity. Differences in height, whether in the form of natural differences or artifacts produced by preparation, take on a 3D effect as relief-like structures.

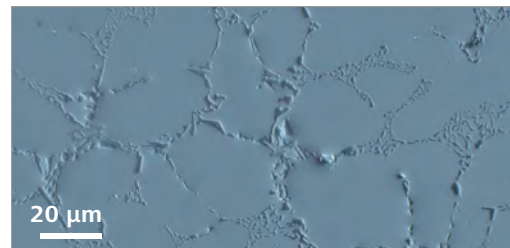

Cast aluminium, 500x, C-DIC. Photo courtesy: Allied High Tech Products Inc.

ZEISS Axiovert at Work: Materialography

- › In Brief
- › The Advantages
- › **The Applications**
- › The System
- › Technology and Details
- › Service



Welding joint. Brightfield, EC Epiplan 5x/0.13

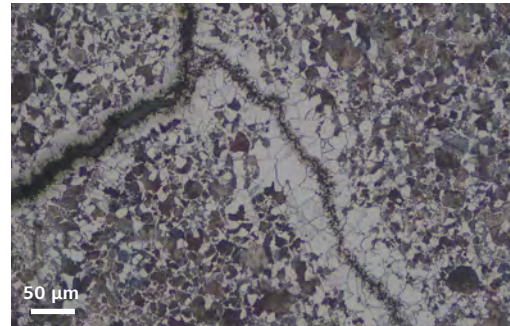

Hardness crack C60 Steel, brightfield, EC Epiplan 20x/0.4

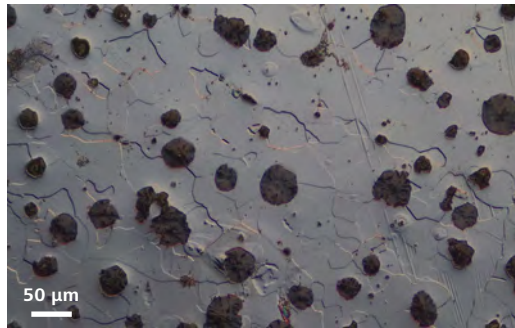

Cast Iron, Circular-Differential Interference Contrast (C-DIC) EC Epiplan 20x/0.4

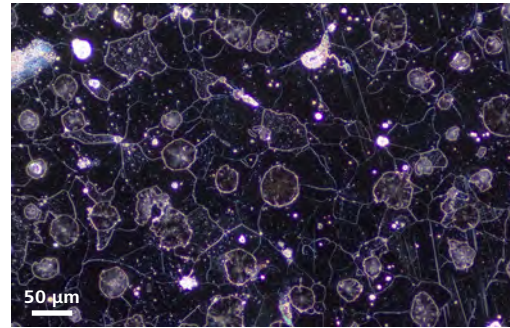

Cast Iron, Darkfield Contrast (DF), EC Epiplan 20x/0.4

Typical tasks and applications

- Determine grain sizes, structure, distribution and phases
- Quickly carry out on-site analysis
- Study modes of material failure: fatigue, corrosion, creep deformation, stress cracks or fractures

How you benefit from ZEISS Axiovert

- Clearly visualize all sample features – Axiovert supports your examination with all essential contrast methods including darkfield and differential interference contrast (DIC)
- Get your work done quickly and easily – the Smart Microscopy concept assures simple operation and rapid image acquisition
- See your samples as they really are – document your sample just as you see it through the eye piece
- Provide reproducible results – encoded components assure that you always get the right light intensity and scaling

ZEISS Axiovert at Work: Materials Science

- › In Brief
- › The Advantages
- › **The Applications**
- › The System
- › Technology and Details
- › Service



Lithium ion battery. Brightfield, EC Epiplan 20×/0.4

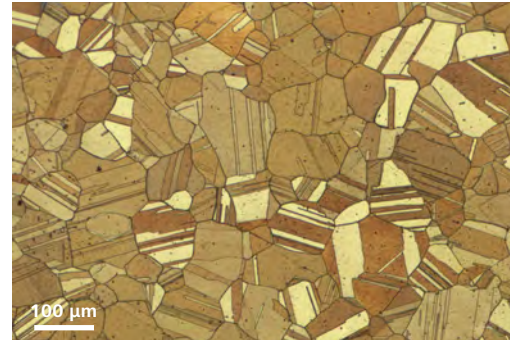

Copper, brightfield, EC Epiplan-Neofluar 10×/0.25



Aluminum anodized, Polarization Contrast, EC Epiplan-Neofluar 5×/0.13

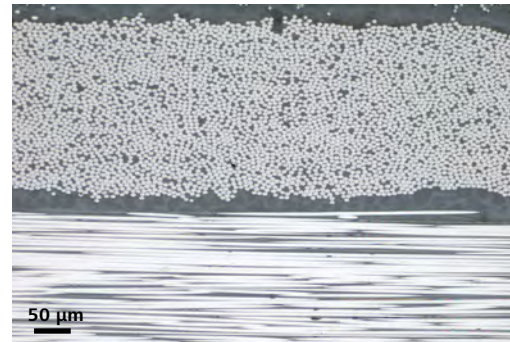

Carbon fiber reinforced polymer, EC Epiplan 20×/0.4

Typical tasks and applications

- Analysis of structure (e.g. phases, grain sizes, texture, precipitates) and structural defects (e.g. inclusions, porosities, voids, cracks)
- Measurement of layer thicknesses and geometric properties
- Analysis of anisotropic samples in polarization contrast (e.g. grain size of aluminum alloys by Barker etching, zinc alloys, graphite, titanium alloys, magnetic materials)

How you benefit from ZEISS Axiovert

- Clearly visualize all sample features – Axiovert supports your examination with all essential contrast methods including darkfield and differential interference contrast (DIC)
- Improve your statistics with large area scanning of your sample with motorized XY stage
- Get more meaningful results from your images with ZEN core microscopy analysis software.
- Provide reproducible results – encoded components assure that you always get the right light intensity and scaling

ZEISS Axiovert at Work: Metallography

- › In Brief
- › The Advantages
- › **The Applications**
- › The System
- › Technology and Details
- › Service

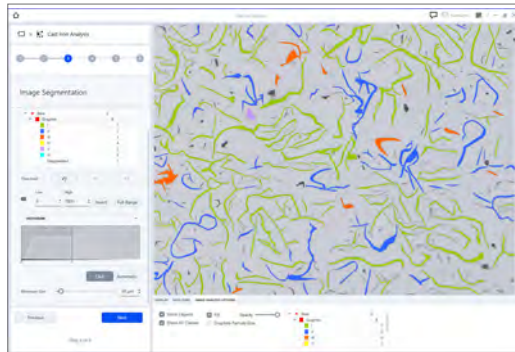

Cast Iron Analysis – image segmentation step

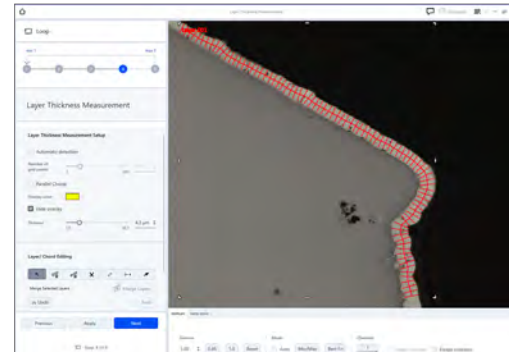

Layer Thickness Measurement – automatic detection of a layer

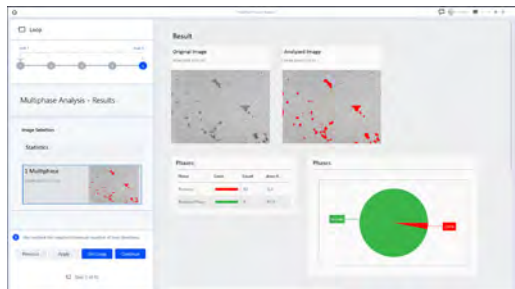

Multiphase Analysis – result view with distribution of different phases

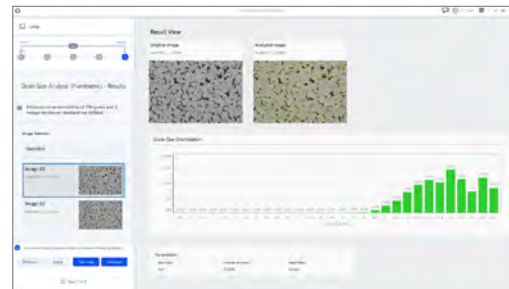

Planimetric Grain Size Analysis – result view

Typical tasks and applications

- Imaging and analysis of microstructure of metal materials
- Quantitative microstructure analysis
- Evaluation according to international standards
- Grain size analysis
- Multiphase analysis

Get these benefits from ZEISS Axiovert

- Reveal microstructural information using different contrast methods
- Use brightfield contrast to get information about the overall number, size and shape of features within a material
- Enhance grain boundaries and particle edges with darkfield contrast to reveal sharper features and clearer definition of interfaces
- With circular differential interference contrast (C-DIC) your sample surface appears as a 3D relief so you can easily detect polishing marks
- Acquire large areas easily with a motorized stage
- Encoded components assure that you always get the right light intensity and scaling to provide reproducible results

ZEISS Axiovert at Work: Non-Metallic Inclusions

- › In Brief
- › The Advantages
- › **The Applications**
- › The System
- › Technology and Details
- › Service

Non-Metallic Inclusion Analysis

The type and amount of non-metallic inclusions (NMI) in steels strongly affect the mechanical and physical properties of these steels.

Metallographic analysis of NMI is governed by industry standards that are supported by the modular and customizable ZEN core software which guides the user quickly and easily through the workflow, generating a report and inclusion gallery compliant with the standards.

Axiovert 7 with ZEISS ZEN module Non-Metallic Inclusion Analysis confirms that manufacturing processes, grade and quality of the product meet strict specifications for impurities or defects that can cause a component to fail or impact its tensile strength, toughness and fatigue.

Powerful inspection views and automated deformation axis detection features make analysis easy, intuitive and repeatable. With additional GxP functionality, ZEN core users are able to offer their customers full traceability and data integrity in NMI analyses, meaning that grade certification is auditable, particularly advantageous for customers in regulated industries

Supported Standards

- ASTM E45
- ISO 4967
- JIS G0555
- GB/T 10561
- EN 10247
- SEP 1571
- DIN 50602



Axiovert 7 with motorized Z-focus and motorized XY stage for NMI analysis

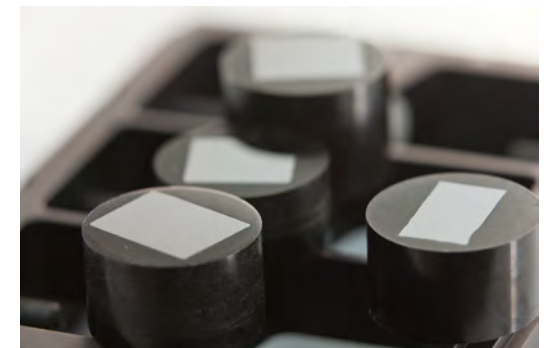

Typical samples for NMI analysis

Your Flexible Choice of Components

- › In Brief
- › The Advantages
- › The Applications
- › **The System**
- › Technology and Details
- › Service

ZEISS Axiovert Systems for Material Applications

The Axiovert systems offer instrument variants for routine tasks and advanced research applications. Each configuration has been optimized for specific applications with all relevant contrast techniques available to support your needs.

ZEISS Axiovert 5

Manual microscope with coded components for reproducible and reliable results of samples acquired with reflected light such as metallographic cuts and large specimens.

ZEISS Axiovert 5 for Reflected and Transmitted Light

Add additional transmitted light contrast capability to Axiovert. Broaden your application space and examine transparent or thin cut samples.

ZEISS Axiovert 7

Motorized microscope with coded components for applications with demands on workflow automation and advanced imaging tasks.



ZEISS Axiovert 5 RL SCB
For reflected light



ZEISS Axiovert 5 RL TL SCB
For reflected and transmitted light



ZEISS Axiovert 7 RL

Your Flexible Choice of Components

- › In Brief
- › The Advantages
- › The Applications
- › **The System**
- › Technology and Details
- › Service



1 Microscope

- Axiovert 5
- Axiovert 7

2 Recommended Classes of Objectives

- EC-Epiplan
- EC-Epiplan-Neofluar



3 Recommended Cameras

- AxioCam 105
- AxioCam 208
- AxioCam 305
- AxioCam 705
- AxioCam 712

4 Stages

- Mechanical Stage
- Gliding Stage
- Scanning Stage



Operating Modes

- Stand-Alone Operation (without PC)
via On Screen Display (OSD)
- Via Labscope
- Via ZEN core on PC

System Overview

- › In Brief
- › The Advantages
- › The Applications
- › The System
- › Technology and Details
- › Service

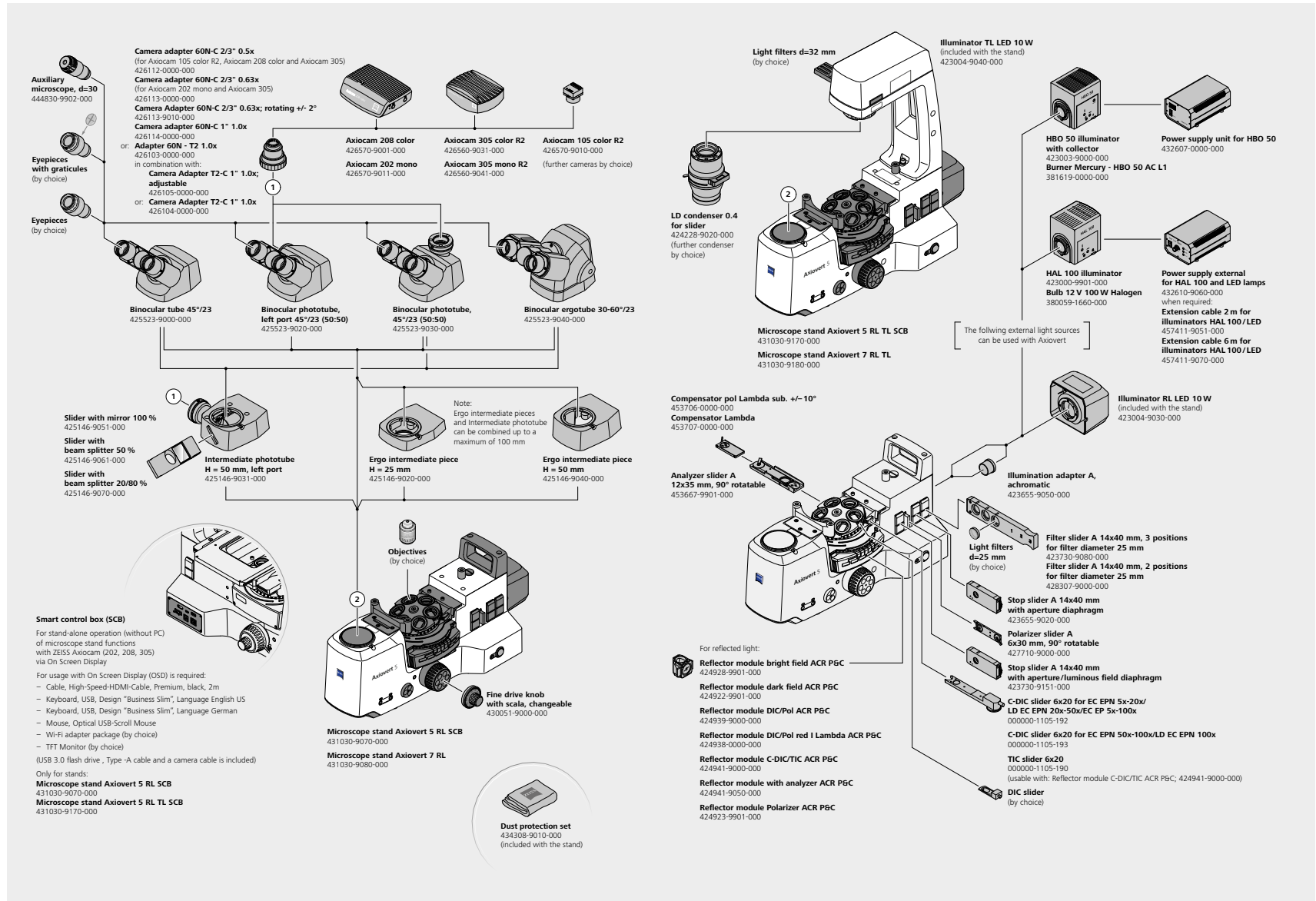

System Overview

- › In Brief
- › The Advantages
- › The Applications
- › The System
- › **Technology and Details**
- › Service

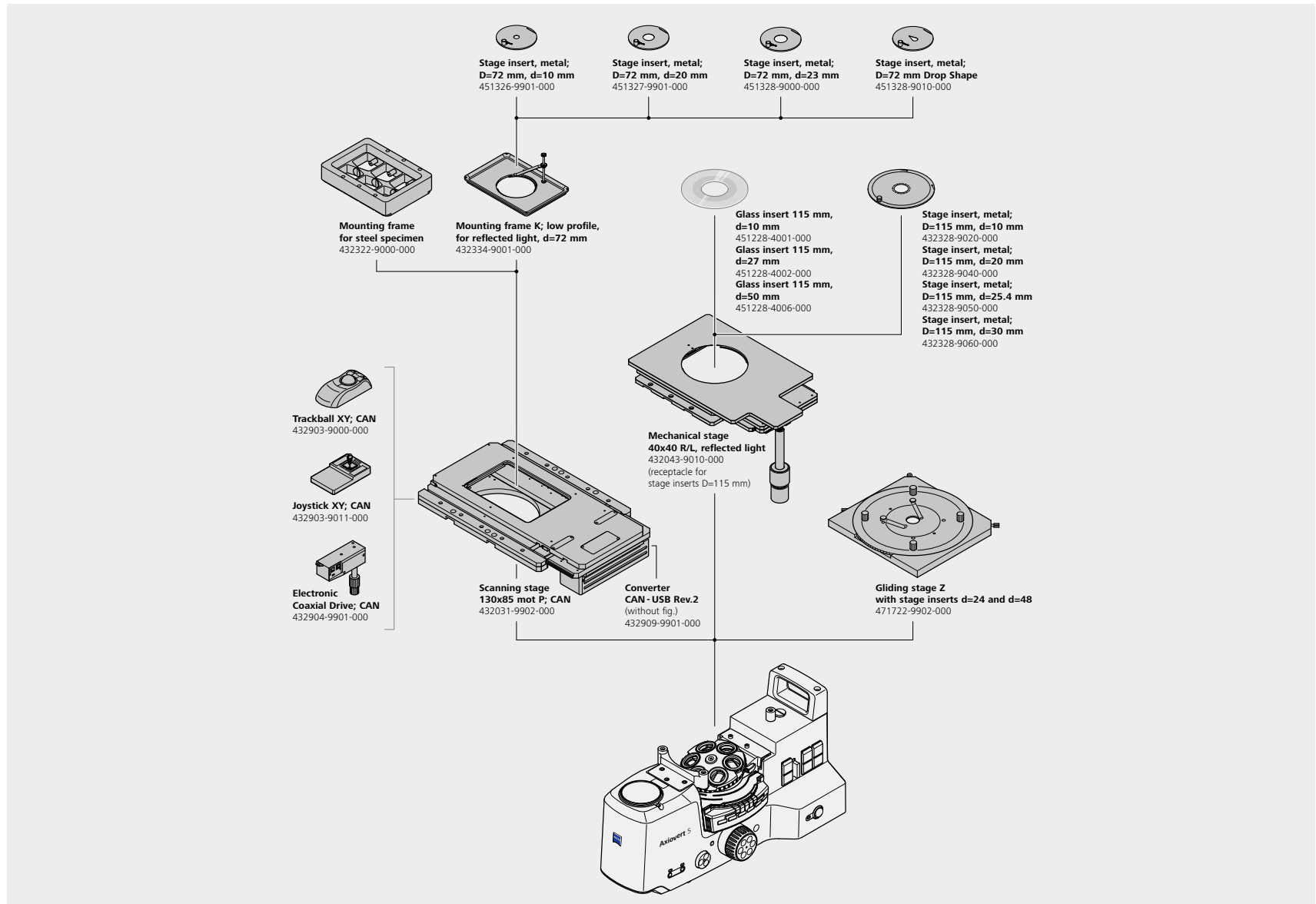

Technical Specifications

- › In Brief
- › The Advantages
- › The Applications
- › The System
- › **Technology and Details**
- › Service

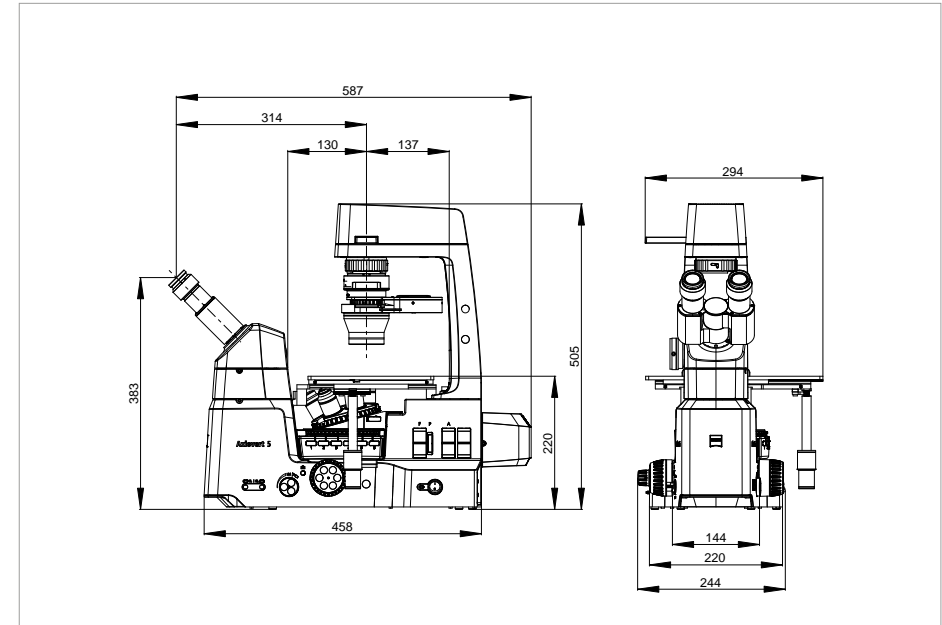
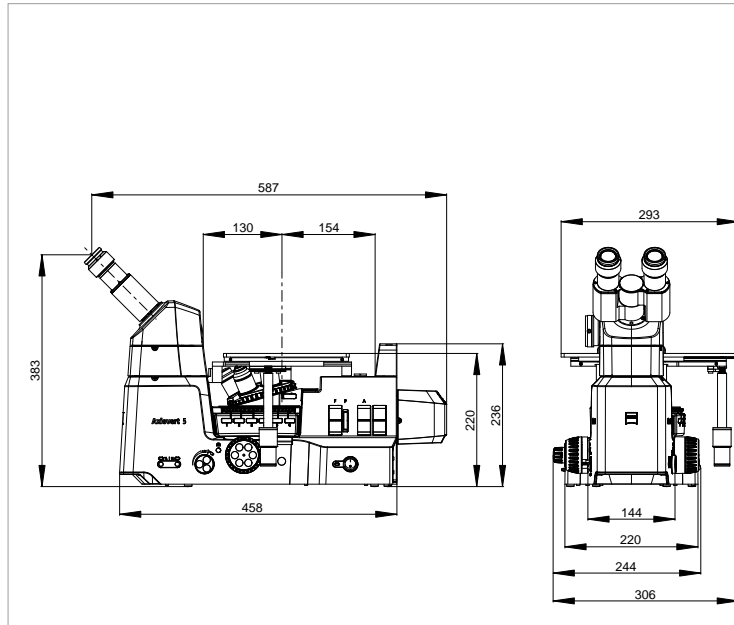

Weight and sizes	ZEISS Axiovert 5 RL SCB	ZEISS Axiovert 5 RL TL SCB	ZEISS Axiovert 7 RL	ZEISS Axiovert 7 RL TL
Dimensions	587 × 306 × 383 (L × W × H in mm)	587 × 294 × 505 (L × W × H in mm)	587 × 306 × 383 (L × W × H in mm)	587 × 294 × 505 (L × W × H in mm)
Weight	10.5 kg	13 kg	10.7 kg	13 kg

Technical Specifications

- › In Brief
- › The Advantages
- › The Applications
- › The System
- › **Technology and Details**
- › Service

	ZEISS Axiovert 5 RL SCB	ZEISS Axiovert 5 RL TL SCB	ZEISS Axiovert 7 RL	ZEISS Axiovert 7 RL TL
Air Conditioning and Quality				
Temperature range for operation with indicated performance (24 h per day, regardless of whether the microscope is in operation or switched off)			5 – 40 °C	
Relative Humidity			< 80 % at 40 °C	
Atmospheric Pressure / Altitude			800 to 1060 hPa / ≤ 2000 m above sea level	
Pollution Degree			2	
Mains Connection				
Nominal AC Voltage			L/N/PE 100 to 240 VAC ± 10 %	
Nominal Frequency			50/60 Hz	
Max. Current			1.4 A	
Rating for Microscope Stand			24 VDC, 5 A	
Protection Class			IP20 (IEC 60529)	
Overvoltage Category			II	
System Features				
Optical System			Infinte, ICS	
Nosepiece			6× nosepiece, encoded	
Reflector Turret			6× reflector turret, encoded	
Focus	manual coarse / fine focus; 13 mm focus range with adjustable focus stop		motorized focus drive (resolution 78 nm) 13 mm focus range with adjustable focus stop	
Reflected Light Illumination (included)			White 10 W LED, average lifetime >60000 hrs	
Contrast Methods (Reflected Light / Transmitted Light)				
Brightfield	●/○	●/●	●/○	●/●
Darkfield	●/○	●/○	●/○	●/○
Polarization	●/○	●/●	●/○	●/●
Differential Interference Contrast (DIC)	●/○	●/●	●/○	●/●
Circular Differential Interference Contrast (C-DIC)	●/○	●/○	●/○	●/○
Total Interference Contrast (TIC)	●/○	●/○	●/○	●/○
Snap Button on Stand	Ergonomically positioned on both sides of the stand; allows to snap images, record videos, start workflows			
Light Manager	Set, save and recall the optimal image brightness according to specific combination of nosepiece position and reflector turret position.			

- useable
- not useable

ZEISS Service – Your Partner at All Times

Your microscope system from ZEISS is one of your most important tools. For over 170 years, the ZEISS brand and our experience have stood for reliable equipment with a long life in the field of microscopy. You can count on superior service and support - before and after installation. Our skilled ZEISS service team makes sure that your microscope is always ready for use.

- › In Brief
- › The Advantages
- › The Applications
- › The System
- › Technology and Details
- › **Service**

Procurement

- Lab Planning & Construction Site Management
- Site Inspection & Environmental Analysis
- GMP-Qualification IQ/OQ
- Installation & Handover
- IT Integration Support
- Startup Training

Operation

- Predictive Service Remote Monitoring
- Inspection & Preventive Maintenance
 - Software Maintenance Agreements
 - Operation & Application Training
 - Expert Phone & Remote Support
 - Protect Service Agreements
 - Metrological Calibration
 - Instrument Relocation
 - Consumables
 - Repairs

New Investment

- Decommissioning
- Trade In

Retrofit

- Customized Engineering
- Upgrades & Modernization
- Customized Workflows via APEER

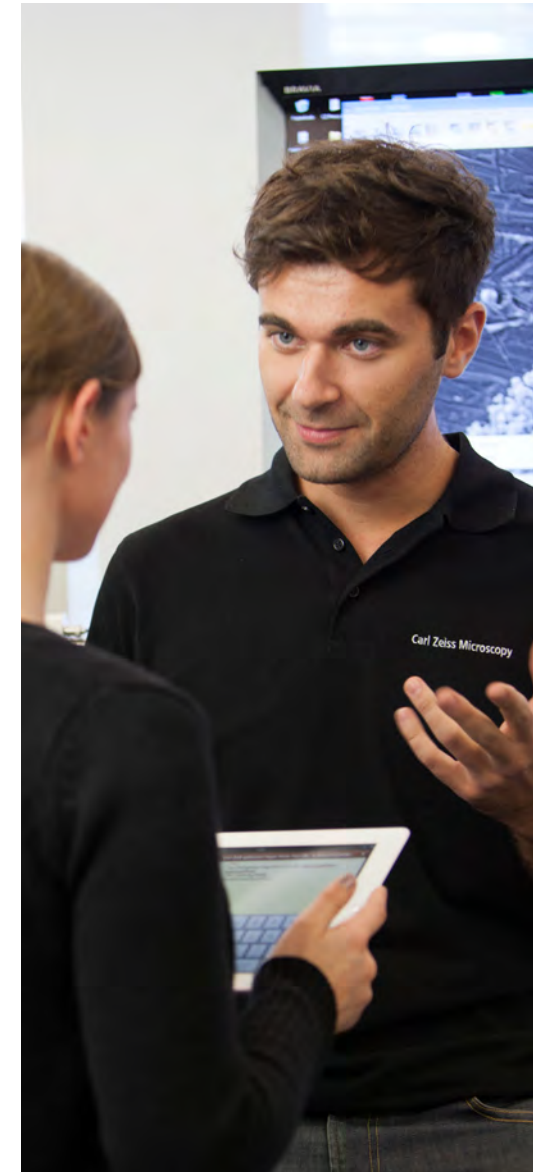

Please note: Availability of services depends on product line and location

>> www.zeiss.com/microservice



Carl Zeiss Microscopy GmbH
07745 Jena, Germany
microscopy@zeiss.com
www.zeiss.com/axiovert-mat

FOR MORE INFORMATION/QUOTATION CONTACT:

ALLIED HIGH TECH PRODUCTS - EXCLUSIVE DISTRIBUTOR
800-675-1118 (US/Canada)
info@alliedhightech.com
www.alliedhightech.com